

Spray device for surgical glue Glubran® 2

Ref. G2-NBT

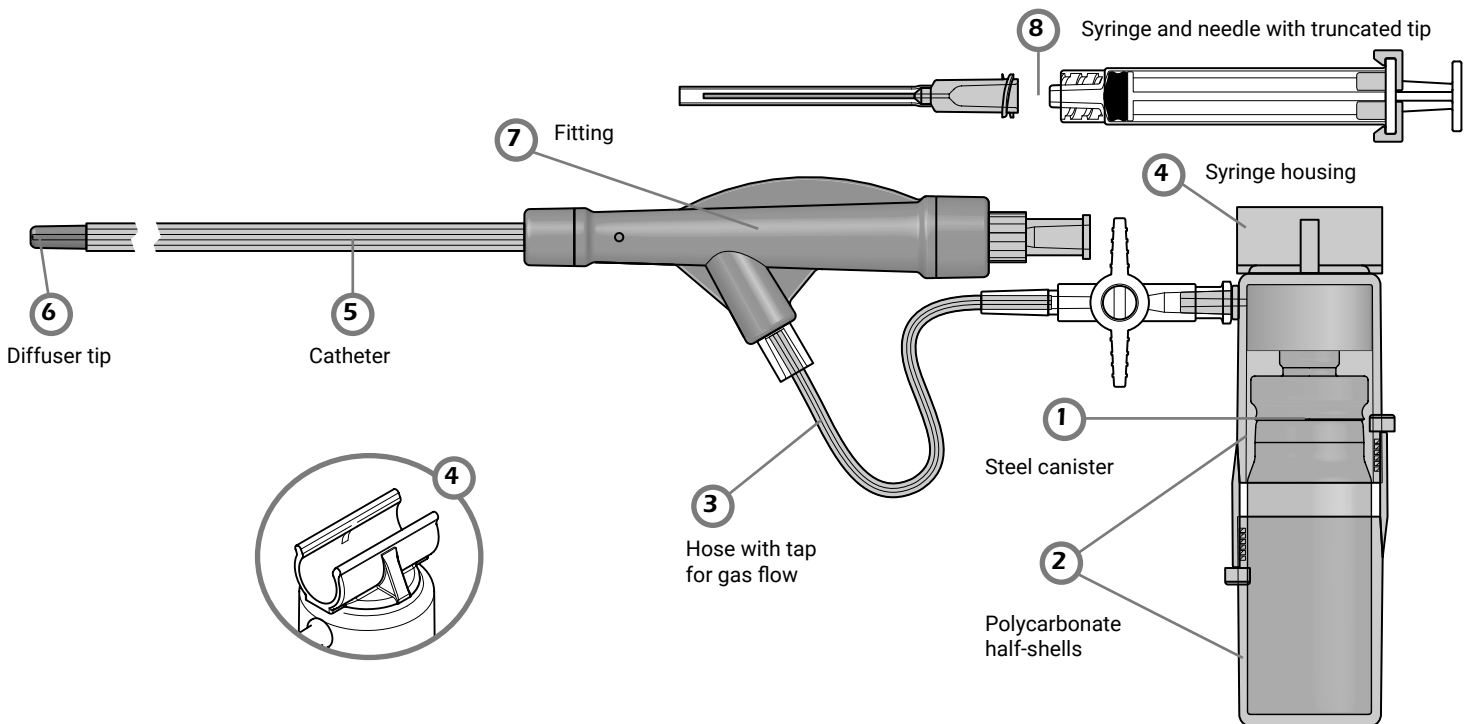

Features

The medical Spray device is used to apply Glubran® 2 Surgical Glue in spray form in laparotomic, laparoscopic and thoracoscopic surgical procedures.

With regard to the applications of Glubran® 2 Surgical Glue, refer to the Intended Use indicated on the Technical Data Sheet of Glubran® 2.

The system consists of:

- a **steel canister** (item 1 in the figure) housed in **two polycarbonate half-shells** (item 2 in the figure).

The canister is filled with non-toxic, non-flammable HFC134/a (1,1,1,2 tetrafluoroethane) gas, used as the propellant of Glubran® 2 Surgical Glue.

A hose with tap for gas flow (item 3 in the figure) comes out from the canister valve, through the upper half-shell.

Above the upper half-shell and integral to it there is **the syringe housing** (item 4 in the figure) where Glubran® 2 Surgical Glue is withdrawn.

- a **blue flexible catheter**, 33 cm long, external diameter Ø 5 mm (item 5 in the figure).

Two tubes are inserted inside the catheter, one of which is for gas and the other for Glubran® 2 Surgical Glue. Gas and Glubran® 2 flow into a **diffuser tip** (item 6 in the figure) placed inside the catheter at its distal end, which sprays the product.

- a **fitting**, placed at the proximal end of the catheter (item 7 in the figure), which connects to the gas tube, and via a female luer connection connects to the syringe where the Glubran® 2 Surgical Glue has been withdrawn.

- **two truncated tip needles and two syringes** (item 8 in the figure), intended to withdraw Glubran® 2 from the single-dose vials, supplied separately.

Method of use

After removing the device from its packaging under sterile conditions, withdraw Glubran® 2 Surgical Glue into one or both of the supplied syringes by means of a truncated tip needle with luer connection.

Check that the tap at the outlet of the gas valve is closed.

Press the two halves of the canister (fig.1) **so that they engage with each other.**

At this point the canister is activated and the gas is under operating pressure.

The canister must never be turned upside down when dispensing gas, but used with the syringe housing always facing upwards.

Open the tap to ensure that gas flows from the tip of the catheter and close it again.

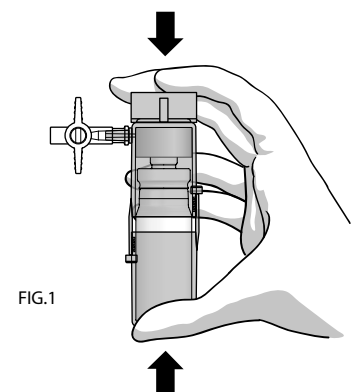

Remove the needle, **screw in the syringe containing Glubran® 2 (fig. 2) to the luer connection of the fitting and position it in the slot above the upper half-shell of the canister** by pushing it fully in (fig. 3).

At the moment of use, open the gas from the butterfly valve. grasp the gas canister with one hand and at the same time with the other hand the distal part of the catheter (fig. 4) and press down on the piston of the syringe to release the sprayed product.

Before use on a patient, do a spray test on a surgical drape in order to assess in advance the correct distance between the catheter tip and the area to be treated (2-5 cm) and the correct pressure to be exerted on the syringe plunger. **Do not allow the tip of the catheter to come into contact with blood or body fluids during the procedure.** In this case, the product will polymerize at the tip of the catheter and occlude it. During surgery, **after each application of Glubran® 2, allow the gas to flow for 5-7 seconds** before closing the gas tap. The purpose of this is to achieve perfect cleaning of the diffuser tip for any subsequent applications.

At the end of surgery, empty the gas canister completely before disposing of the spray device.

The amount of Glubran® 2 Surgical Glue to be applied can vary from 1 to 4 ml depending on the type of surgery and the surface to be treated.

Intended use and indications





Laparotomic, laparoscopic and thoracoscopic surgery.

It is indicated for an adult population awaiting laparotomic, laparoscopic and thoracoscopic surgery in combination with the Glubran® 2 medical device.



Target population

Adults.

Warnings

- ⚠ The spray device must only be used by physicians experienced in the use of the system.
- ⚠ Read the instructions before use. 
- ⚠ Do not use the product if the package has been damaged or tampered with. 
- ⚠ The gas canister is a pressure vessel. It must be protected from sunlight, must not be exposed to temperatures above 30 °C and must not be perforated or burnt even after use.
- ⚠ Before using the spray always check that the system is functioning correctly by performing a spray test on a surgical drape.
- ⚠ The canister must never be turned upside down when dispensing gas, but used with the syringe housing always facing upwards.
- ⚠ At the end of surgery, empty the gas canister completely before disposing of the device.
- ⚠ During the laparoscopic procedure, in order to achieve a correct application of Glubran® 2 Surgical Glue, it is necessary to reduce the CO₂ pressure to 8-9 mmHg and to block the CO₂ flow in order to avoid the creation of vortices.
- ⚠ **Use protective glasses during the procedure.**
- ⚠ In the event of accidental contact of Glubran® 2 Surgical Glue with the eyes, immediately flush with water. If the product has polymerized, it will detach spontaneously after about 2-3 days.
- ⚠ The system cannot be used to spray liquids other than Glubran® 2 Surgical Glue.
- ⚠ The system is disposable. The system cannot be re-used due to the risk of infection to the patient and the impairment of the functionality and effectiveness of the device.  
- ⚠ The manufacturer will not accept any responsibility for damage caused by improper use or use other than what is shown on this Instruction Sheet.
- ⚠ The device can only be used with trocars with a diameter of at least 5 mm.

Storage

The product must be protected from sunlight and stored at temperatures not exceeding 30 °C.  

Disposal

Once used, dispose of the device according to local procedures and guidelines.

Expiry date

The expiry date is shown on the package.

Sterility

The product is gamma-sterilised.  

Contact

Any serious incident occurring with the device must be reported to the manufacturer GEM S.r.l. and to the competent authority of the Member State in which the user and/or patient is established.

Packaging

Single package. 

Product code

 G2-NBT

Class

Ila

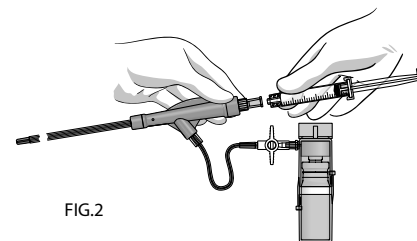

FIG.2

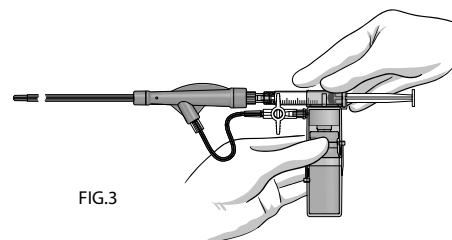

FIG.3

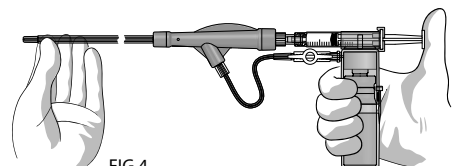

FIG.4